

## PATENT ABSTRACTS OF JAPAN

(11)Publication number : 2004-008751

(43)Date of publication of application : 15.01.2004

(51)Int.Cl. A61H 1/02  
A63B 69/00

(21)Application number : 2002-201946

(71)Applicant : GO KENSEI  
KAKIHARA KIYOAKI

(22)Date of filing : 06.06.2002

(72)Inventor : GO KENSEI

## (54) REMOTE REHABILITATION SUPPORTING SYSTEM

(57)Abstract:

**PROBLEM TO BE SOLVED:** To provide a remote rehabilitation supporting system which creates an attending environment such as receiving a face-to-face instruction from a therapist by an audiographic communication while staying home, and an operation environment such that the therapist remotely moves the body of a trainee through a network.

**SOLUTION:** This remote rehabilitation supporting system is equipped with a device which reproduces the biological movement characteristics of an advanced age person, a physically challenging person or a patient and so forth (referred to as the trainee) for the purpose of being operated by the therapist, a device for the purpose of moving the body of the trainee conforming to the operating motion by the therapist, and an audiographic communicating device. The remote rehabilitation supporting system performs the support for a home rehabilitation training through a network.

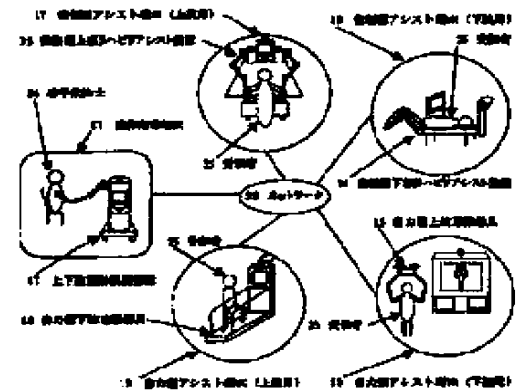

\* NOTICES \*

**JPO and INPIT are not responsible for any damages caused by the use of this translation.**

- 1.This document has been translated by computer. So the translation may not reflect the original precisely.
- 2.\*\*\*\* shows the word which can not be translated.
- 3.In the drawings, any words are not translated.

---

## CLAIMS

---

[Claim(s)]

[Claim 1]

A remote rehabilitation supporting system which is provided with the following and characterized by offering support for rehabilitation via a network.

A mechanism which considers living body movement characteristics, such as elderly people, a disabled person, and a patient (henceforth a \*\*\*\* person), as reappearance for the purpose of making a physical therapist operate it (henceforth a "movement imitation mechanism").

A mechanism aiming at moving a \*\*\*\* person's body according to said physical therapist's operation operation (henceforth an "assist mechanism").

[Claim 2]

A remote rehabilitation supporting system reproducing operation which operates a physical therapist's movement imitation mechanism via a network to an assist mechanism installed in a \*\*\*\* person house, and moving said \*\*\*\* person's body compulsorily.

[Claim 3]

A remote rehabilitation supporting system, wherein it animates normative rehabilitation operation, it transmits to a \*\*\*\* person house via a network and said \*\*\*\* person moves the own body by himself according to said animation.

[Claim 4]

A remote rehabilitation supporting system given in either from Claim 1 having a movement imitation mechanism for upper membrum inferius, a digital camera, a screen-display machine, a microphone, loudspeakers, and those control devices (henceforth an upper membrum-inferius movement mimicking device), and performing remote control instruction to a \*\*\*\* person to Claim 3.

[Claim 5]

It has a mechanism, digital cameras, screen-display machines, microphones and loudspeakers which move an upper extremity or membrum inferius compulsorily, and those control devices. (— a following and compulsion draw spike (lower) — a leg — it is called a rehabilitation assist device. being based on operation of) and a physical therapist — a \*\*\*\* person's upper and lower sides — moving a leg compulsorily — said \*\*\*\* person's upper and lower sides — a leg — a remote rehabilitation supporting system given in either from Claim 1 recovering a motor function to Claim 4.

[Claim 6]

It has own strength type sports equipment, a digital camera, a screen-display machine, a microphone, and a loudspeaker, A remote rehabilitation supporting system given in either from Claim 1 recovering said \*\*\*\* person's living body motor function when a \*\*\*\* person repeats and moves the own body by himself according to instruction operation which animated normative rehabilitation operation to Claim 4.

[Claim 7]

A remote rehabilitation supporting system given in either from Claim 1, wherein confrontation conversation is made in a real timer by voice pictorial communication between a physical therapist and a \*\*\*\* person to Claim 6.

---

[Translation done.]

**\* NOTICES \***

**JPO and INPIT are not responsible for any damages caused by the use of this translation.**

- 1.This document has been translated by computer. So the translation may not reflect the original precisely.
- 2.\*\*\* shows the word which can not be translated.
- 3.In the drawings, any words are not translated.

---

**DETAILED DESCRIPTION**

---

[Detailed Description of the Invention]

[0001]

[Field of the Invention]At this invention, it is \*\*\*\*\*]. In this invention, physical therapists are upper membrum-inferius movement characteristics, such as elderly people, a disabled person, and a patient.

Therefore, remote rehabilitation support Si who carries out operation instruction to those who receive home rehabilitation via a network by operating equipment.

In this Description, elderly people, a disabled person, a patient, etc. who perform rehabilitation are called "\*\*\*\* person." Movement transitively moved by a patient's physical therapist, an instrument, or own healthy part is called "forced movement type rehabilitation", and movement moved by a patient's own power to it is called "own strength motor type rehabilitation." It is called "home rehabilitation" to perform rehabilitation to a house, a home for the aged, etc.

[0002]

[Description of the Prior Art]About rehabilitation support, there are two kinds of mainly following conventional technologies.

- 1) It is an assist device aiming at mitigation of a physical therapist's physical strength burden, and relaxation of a physical therapist insufficient problem. Usually, it is installed in a rehabilitation center.
- 2) Assistance aiming at mitigation of ambulatory and the going-to-hospital-regularly burden of a patient, and promotion of home rehabilitation

It is equipment. It is mainly installed in a \*\*\*\* person's house.

[0003]These researches aim at development of the autonomy type rehabilitation assist device of replacing and acting for all physical therapists. Such a rehabilitation assist device can expect to be useful for solution of the problem that a physical therapist is insufficient, or relaxation of a physical therapist's physical strength burden, but on the other hand the insecurity of the \*\*\*\* person by a physical therapist's absence produces it. Much problems remain also in the field of intelligence.

[0004]

[Problem to be solved by the invention]There were the following faults in the conventional rehabilitation support device.

- 1) The body of the \*\*\*\* person by ambulatory and going to hospital regularly when a rehabilitation support device is installed in a hospital The problem that the burden of power and the financial side is heavy is left behind.
- 2) When a rehabilitation support device is installed in a house, the insecurity of the \*\*\*\* person by a physical therapist's absence arises.

[0005]Since rehabilitation called the kinesitherapy must be performed continuously, of course, it is important during hospitalization to continue rehabilitation also in being home. the point of home rehabilitation -- oneself -- it is having the intention carried out firmly and moving all the joints of hand and foot by a right position in a movable range every day. However, when rehabilitation is neglected at a house or a bad posture and self-taught training are performed just because rehabilitation recovered the physical exertion function once in the hospital, there is often a case which fell the motor function again. This is because the rehabilitation in the house was exact and was not performed to continuation. Therefore, in order to secure the effect of home rehabilitation, the supporting system that remote instruction and operation from a family doctor or a physical therapist can be received at a house is required.

[0006]Presence environment where this invention is not replacing and acting for all physical therapists here, and voice pictorial communication receives confrontation instruction from a

physical therapist at a house, A remote rehabilitation supporting system which builds an operating environment that a physical therapist moves a \*\*\*\* person's body remotely via a network is provided. Thereby, rehabilitation is made to perform on an exact target and a continuation target under environment safe to a \*\*\*\* person of being home. Though it is in a house, rehabilitation in character with human being like confrontation training with a physical therapist and a \*\*\*\* person is attained.

[0007]

[Means for solving problem]Equipment which reproduces a \*\*\*\* person's living body movement characteristic for the purpose of making a physical therapist operate this invention in order to solve the above problem, It has equipment aiming at moving a \*\*\*\* person's body according to said physical therapist's operation operation, and voice pictorial communication equipment, and support for home rehabilitation training is offered via a network.

[0008]

[Mode for carrying out the invention]Drawing 1 is a block diagram of an upper membrum-inferius movement mimicking device. Drawing 2 is a block diagram of an exerted type upper extremity rehabilitation assist device of coercion. Drawing 3 is a block diagram of an own strength type assistant terminal for upper extremities.

[0009]Drawing 4 shows the 1st working example of this invention. The operation which operates the upper membrum-inferius movement mimicking device of the physical therapist of the operation instruction terminal side is reproduced via a network to the upper extremity rehabilitation assist device installed in the \*\*\*\* person side house. According to the operation, an upper extremity rehabilitation assist device moves the body compulsorily, applying the suitable power for a \*\*\*\* person. Since an upper membrum-inferius movement mimicking device reproduces a \*\*\*\* person's living body movement characteristic, the physical therapist can sense an operation feeling which operates a \*\*\*\* person directly.

[0010]Drawing 5 shows the 2nd working example of this invention. Normative rehabilitation operation is animated and it transmits to a \*\*\*\* person house via a network. A \*\*\*\* person moves the own body by himself according to the animation. Simultaneously, a physical therapist teaches a \*\*\*\* person instancy by TV monitor. Carrying out rehabilitation can make hot and severe rehabilitation interesting, looking at animation.

[0011]Drawing 6 shows the 3rd working example of this invention. By connecting one operation instruction terminal and many assistant terminals via a network, one physical therapist can do simultaneous instruction of many home \*\*\*\* persons.

[0012]

[Effect of the Invention]This invention has the following effects.

- 1) Cancel the anxiety of the home \*\*\*\* person by a physical therapist absence. It secures an exact target and making it carry out continuously for the home rehabilitation TEJON.
- 2) Since one physical therapist can guide many home \*\*\*\* persons, he eases the problem that a physical therapist is insufficient. A physical therapist's physical strength burden is eased.
- 3) In response to the U.N. declaration of "ten years of a bone, a joint, and a muscle", it will be useful for solution and prevention of the 1st problem "arthralgia" of world health care from 2000.
- 4) Ease the caring burden of an aging society by reducing the number of person requiring cares at the same time it maintains the suitable motor function for elderly people and a disabled person and improves the independence viability.

[Brief Description of the Drawings]

Drawing 1It is a block diagram of the upper membrum-inferius movement mimicking device of this invention.

Drawing 2It is a block diagram of the exerted type upper extremity rehabilitation assist device of this invention of coercion.

Drawing 3It is a block diagram of the own strength type assistant terminal (for upper extremities) of this invention.

Drawing 4The 1st working example of this invention -- It is a block diagram of the support for forced movement type rehabilitation.

Drawing 5The 2nd working example of this invention -- It is a block diagram of the support for own strength motor type rehabilitation.

Drawing 6The 3rd working example of this invention -- It is a block diagram of a one-to-many type home rehabilitation supporting system.

[Explanations of letters or numerals]

1 -- Digital camera

- 2 -- Screen-display machine
- 3 -- Loudspeaker
- 4 -- Microphone
- 5 -- Top membrum-inferius movement imitation mechanism
- 6 -- Left upper extremity drive mechanism
- 7 -- Left elbow supporter
- 8 -- Right upper extremity drive mechanism
- 9 -- Right elbow supporter
- 10 -- Control device
- 11 -- Good moving base
- 12 -- Top membrum-inferius movement mimicking device
- 13 -- Exerted type upper extremity rehabilitation assist device of coercion
- 14 -- Exerted type membrum-inferius rehabilitation assist device of coercion
- 15 -- Own strength type upper extremity sports equipment
- 16 -- Own strength type membrum-inferius sports equipment
- 17 -- Exerted type [ of coercion ] assistant terminal (for upper extremities)
- 18 -- Exerted type [ of coercion ] assistant terminal (for membrum inferius)
- 19 -- Own strength type assistant terminal (for upper extremities)
- 20 -- Own strength type assistant terminal (for membrum inferius)
- 21 -- Operation instruction terminal
- 22 -- Network
- 23 -- Voice pictorial communication equipment
- 24 -- Physical therapist
- 25 -- \*\*\*\* person

---

[Translation done.]

(19) 日本国特許庁(JP)

(12) 公開特許公報(A)

(11) 特許出願公開番号

特開2004-8751  
(P2004-8751A)

(43) 公開日 平成16年1月15日(2004.1.15)

(51) Int. Cl.<sup>7</sup>

A61H 1/02  
A63B 69/00

F 1

A61H 1/02  
A63B 69/00

G  
C

テーマコード (参考)

審査請求 未請求 請求項の数 7 書面 (全 5 頁)

(21) 出願番号 特願2002-201946 (P2002-201946)  
(22) 出願日 平成14年6月6日 (2002.6.6)

(71) 出願人 502248810  
呉 建青  
愛知県豊橋市高師町字北原 1 番地 9 6 (8-202)  
(71) 出願人 595165405  
柿原 清章  
愛知県南設楽郡鳳来町乗本字新井貝津 5 4  
(72) 発明者 呉 建青  
愛知県豊橋市高師町字北原 1 番地 9 6 (8-202)

(54) 【発明の名称】 遠隔リハビリ支援システム

(57) y v æ

y Ł z { > " A " " 重  
% ' w ^ @ m ' ° 鑑  
« ~ A w ^ @ m " l b g 取  
u I fi ' • / " / << 器  
V X e æ • Ø  
y Ł i z " a Ł 薬  
w ^ @ m † " Ø - ~ 器  
‡ " · i P " ~ □ / 器  
Ø u ~ A O L w ^ @ m 器  
fi ' • - ~ I ~ • Ø 器  
u ~ 1 f ~ A l b g [ 器  
ß x s / - ~ 、 ¥ 器  
X e - Ø  
y I } Ø

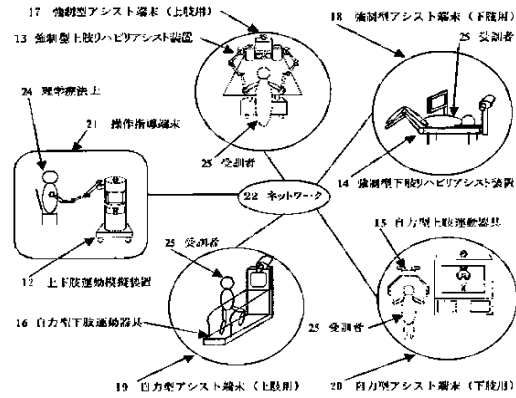









Y } E

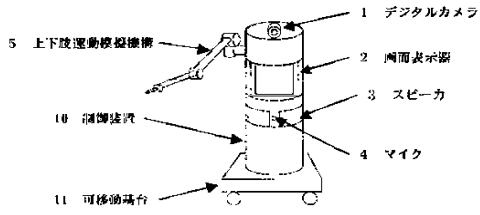

Y } E

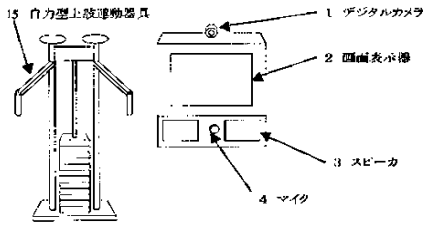

Y } E

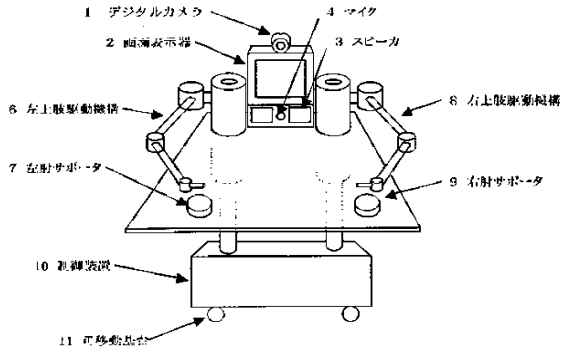

Y } S

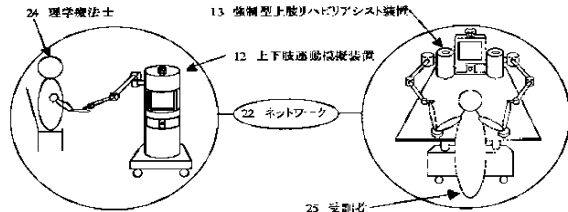

Y } E

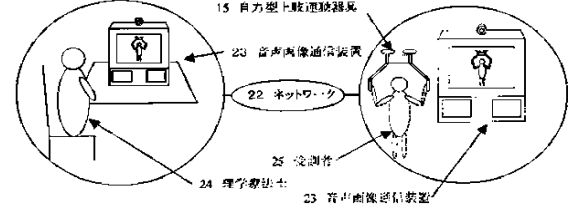

Y } E

